

# Invacare® SB® 755



en Bed  
User Manual

This manual **MUST** be given to the user of the product.  
**BEFORE** using this product, this manual **MUST** be read and saved  
for future reference.



**Yes, you can.®**

©2024 Invacare Corporation

All rights reserved. Republication, duplication or modification in whole or in part is prohibited without prior written permission from Invacare. Trademarks are identified by ™ and ®. All trademarks are owned by or licensed to Invacare Corporation or its subsidiaries unless otherwise noted.

<b>1 General</b> . . . . .	<b>4</b>
1.1 Introduction . . . . .	4
1.1.1 Symbols in this Document . . . . .	4
1.2 Service Life . . . . .	4
1.3 Compliance . . . . .	4
1.3.1 Product-specific standards . . . . .	4
1.4 Warranty Information . . . . .	4
1.5 Limitation of Liability . . . . .	4
<b>2 Safety</b> . . . . .	<b>5</b>
2.1 General safety information . . . . .	5
2.2 Mattresses . . . . .	6
2.3 Safety information on electromagnetic interference . . . . .	6
2.4 Labels and symbols on the product . . . . .	7
2.4.1 Identification Label . . . . .	7
2.4.2 Other Labels . . . . .	7
<b>3 Product Overview</b> . . . . .	<b>9</b>
3.1 Intended Use . . . . .	9
3.1.1 Intended Operator . . . . .	9
3.2 Main parts of bed . . . . .	9
3.3 Options . . . . .	9
<b>4 Usage</b> . . . . .	<b>11</b>
4.1 General Safety Information . . . . .	11
4.1.1 Mattress retainers . . . . .	11
4.2 Setup . . . . .	11
4.3 Operating side rails . . . . .	11
4.3.1 Operating Scala 2 side rail . . . . .	11
4.3.2 Britt V and Line side rails . . . . .	12
4.3.3 Verso II side rails . . . . .	12
4.4 Hand Control . . . . .	12
4.4.1 Locking function . . . . .	12
4.5 Soft Control . . . . .	13
4.6 Castors and brakes . . . . .	13
4.6.1 Central brake system . . . . .	13
4.7 Lifting pole . . . . .	13
4.7.1 Place the lifting pole . . . . .	14
4.7.2 Adjusting the handle height . . . . .	14
4.8 Emergency positions . . . . .	14
4.8.1 Emergency release of a mattress support section . . . . .	14
<b>5 Maintenance</b> . . . . .	<b>15</b>
5.1 General maintenance information . . . . .	15
5.1.1 Service interval . . . . .	15
5.2 Daily inspections . . . . .	15
5.3 Cleaning and Disinfection . . . . .	15
5.3.1 General safety information . . . . .	15
5.3.2 Cleaning Intervals . . . . .	15
5.3.3 Cleaning Instructions . . . . .	15
5.3.4 Disinfection Instructions . . . . .	16
5.4 Lubrication . . . . .	16
<b>6 After Use</b> . . . . .	<b>17</b>
6.1 Disposal . . . . .	17
6.2 Reconditioning . . . . .	17
<b>7 Troubleshooting</b> . . . . .	<b>18</b>
7.1 Troubleshooting . . . . .	18
<b>8 Technical Data</b> . . . . .	<b>19</b>
8.1 Dimensions bed . . . . .	19
8.2 Dimensions side rails . . . . .	19
8.3 Maximum weights . . . . .	19
8.4 Weights . . . . .	19
8.5 Allowed mattress sizes . . . . .	20
8.6 Materials . . . . .	20
8.7 Environmental conditions . . . . .	20
8.8 Electrical system . . . . .	21
<b>9 Electromagnetic compatibility (EMC)</b> . . . . .	<b>22</b>
9.1 General EMC information . . . . .	22
9.2 Electromagnetic emission . . . . .	22
9.3 Electromagnetic Immunity . . . . .	22

# 1 General

## 1.1 Introduction

This user manual contains important information about the handling of the product. To ensure safety when using the product, read the user manual carefully and follow the safety instructions.

Only use this product if you have read and understood this manual. Seek additional advice from a healthcare professional who is familiar with your medical condition and clarify any questions regarding the correct use and necessary adjustment with the healthcare professional.

Note that there may be sections in this document, which are not relevant to your product, since this document applies to all available models (on the date of printing). If not otherwise stated, each section in this document refers to all models of the product.

The models and configurations available in your country can be found in the country-specific sales documents.

Invacare reserves the right to alter product specifications without further notice.

Before reading this document, make sure you have the latest version. You find the latest version as a PDF on the Invacare website.

If you find that the font size in the printed document is difficult to read, you can download the PDF version from the website. The PDF can then be scaled on screen to a font size that is more comfortable for you.

For more information about the product, for example product safety notices and product recalls, contact your Invacare distributor. See addresses at the end of this document.

In case of a serious incident with the product, you should inform the manufacturer and the competent authority in your country.

### 1.1.1 Symbols in this Document

Symbols and signal words are used in this document and apply to hazards or unsafe practices which could result in personal injury or property damage. See the information below for definitions of the signal words.



**WARNING**  
Indicates a hazardous situation that could result in serious injury or death if it is not avoided.



**CAUTION**  
Indicates a hazardous situation that could result in minor or slight injury if it is not avoided.



**NOTICE**  
Indicates a hazardous situation that could result in damage to property if it is not avoided.



**Tips and Recommendations**  
Gives useful tips, recommendations and information for efficient, trouble-free use.

### Other Symbols

(Not applicable for all manuals)



**UKRP** UK Responsible Person  
Indicates if a product is not manufactured in the UK.



**Triman**  
Indicates recycling and sorting rules (only relevant for France).

## 1.2 Service Life

The expected service life of this product is eight years when used daily and in accordance with the safety instructions, maintenance intervals and correct use, stated in this manual. The effective service life can vary according to frequency and intensity of use.

## 1.3 Compliance

Quality is fundamental to the company's operation, working within the disciplines of ISO 13485.

This product features the CE mark, in compliance with the Medical Device Regulation 2017/745 Class I.

This product features the UKCA mark, in compliance with Part II UK MDR 2002 (as amended) Class I.

We are continuously working towards ensuring that the company's impact on the environment, locally and globally, is reduced to a minimum.

We only use REACH compliant materials and components.

We comply with the current environmental legislations WEEE and RoHS.

### 1.3.1 Product-specific standards

The product has been tested and conforms to IEC 60601-2-52 (Particular requirements for the basic safety and essential performance of medical beds) and all related standards.

For further information about local standards and regulations, contact your local Invacare representative. See addresses at the end of this document.

## 1.4 Warranty Information

We provide a manufacturer's warranty for the product in accordance with our General Terms and Conditions of Business in the respective countries.

Warranty claims can only be made through the provider from whom the product was obtained.

## 1.5 Limitation of Liability

Invacare accepts no liability for damage arising from:

- Non-compliance with the user manual
- Incorrect use
- Natural wear and tear
- Incorrect assembly or set-up by the purchaser or a third party
- Technical modifications
- Unauthorised modifications and/or use of unsuitable spare parts

## 2 Safety

### 2.1 General safety information

This section of the manual contains general safety information about your product. For specific safety information, refer to the appropriate section of the manual and procedures within that section.



**WARNING!**

**Risk of injury or damage**

- Do not use this product or any available optional equipment without first completely reading and understanding these instructions and any additional instructional material such as user manuals or instruction sheets supplied with this product or optional equipment. If you are unable to understand the warnings, cautions or instructions, contact a healthcare professional, Invacare provider or qualified technician before attempting to use this product.
- Do not make any unauthorized alterations or modifications to the product.



**WARNING!**

**Risk of entrapment / suffocation**

There's a risk of entrapment / suffocation between mattress support, side rail and bed end or between moving parts and objects placed nearby the bed.

- The bed must not be used by persons under 12 years of age, or by persons with a body size equivalent to an average 12 years old or smaller.
- The bed, in combination with side rails must not be used by persons having a physical size less than 146 cm, a weight less than 40 kg or a body mass index (BMI) less than 17.
- Due to mattress compression, an increased risk may occur over time. Periodically monitor gaps between the bed, mattress and/or side rail. Replace mattress if the gaps may lead to entrapment.



**WARNING!**

**Risk of slipping through the openings**

The bed fulfils all requirements regarding maximum distances. However, it is possible that persons with small body dimensions slip through the openings between the side rails or through the opening between the side rail and the mattress support.

- Pay special attention, if the bed is used for the care of persons with small body dimensions.



**WARNING!**

**Risk of injury or damage**

- Inappropriate handling of cables, incorrect connections and use of unauthorized equipment can cause electrical shock and product failure.
- Do not kink, shear or otherwise damage the cables of the product.
  - Make sure that no cables are jammed or damaged, when the product is used.
  - Disconnect the plug from the mains before moving the bed.
  - Make sure the wiring is correct and connections are proper.
  - Do not use unauthorized equipment.



**WARNING!**

**Risk of tripping, entanglement or strangulation**

- Improper routing of cables may cause tripping, entanglement or strangulation hazard.
- Ensure all cables are routed and secured properly.
  - Ensure there are no loops of excess cable extending away from the product.



**WARNING!**

**Risk of injury or damage**

- Ignition sources can cause burns or fire.
- Bed must be placed with a safety space from possible ignition sources (heater, fireplace, etc.)
  - The patient and assistants must not smoke while using or operating the bed.



**WARNING!**

**Risk of injury or damage**

- To avoid injury or damage when operating the product:
- Close supervision is necessary when the product is used near children or pets.
  - Do not let children play with the product.



**CAUTION!**

- For a person entering or exiting the bed, always lower the bed to an appropriate height. For entering or exiting the bed, the backrest section of the mattress support can be used as an assistance. Make sure the patient is laid down at the centre of the backrest section. When the backrest section is being raised the allowed maximum weight for the backrest section is 45% of maximum safe working load.
- Always lower the bed to the lowest position before leaving a person in the bed unattended.
- Make sure that there is nothing under, over, or near the bed that can obstruct the height adjustment, like for example furniture, lifts or window frames.

**CAUTION!**

Non-original or wrong accessories may affect the function and safety of the product.

- Only use original accessories for the product in use.
- Due to regional differences, refer to your local Invacare catalog or website for available accessories or contact your local Invacare representative. See addresses at the end of this document.

**CAUTION!****Risk of injury or damage**

The product can get hot when exposed to sunlight or other heat sources.

- Do not expose the product to direct sunlight for prolonged periods.
- Keep the product away from heat sources.

**CAUTION!**

There is a risk of entrapment of fingers in the bed moving parts.

- Pay attention to your fingers.

**NOTICE!**

The bed has no isolator (main switch). If the bed needs to be electrically disconnected, it has to be unplugged from the mains socket.

- Always place the bed in a way so the mains socket is easily accessible to unplug the bed.

**NOTICE!**

Accumulation of lint, dust and other dirt can impair the product.

- Keep the product clean.

## 2.2 Mattresses

**WARNING!****Safety aspects regarding combination of side rails and mattresses:**

To get the highest possible safety level, when using side rails on the bed, the minimum and maximum measures for mattresses, must be respected.

- For correct mattress measures see mattress table in chapter 8 *Technical Data*, page 19.

**WARNING!****Risk of entrapment and/or suffocation**

– The user could get trapped and/or suffocate, if the horizontal space, between the mattress side and the inside of the side rail, is too big. Follow the minimum width (and length) of mattresses in combination with a side rail, as stated in the mattress table in chapter 8 *Technical Data*, page 19.

- Be aware that using very thick or soft mattresses (low density), or a combination of these, increases the risk.

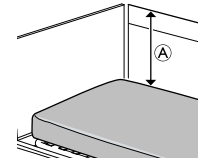
**WARNING!****Risk of falling**

The user can fall over the edge and get seriously injured, if the vertical distance (A) between the top of the mattress and the edge of the side rail/bed end, is too short. See image above.

- Always keep a minimum distance (A) of 22 cm.
- Follow the maximum mattress height in combination with the side rail as stated in the mattress table in chapter 8 *Technical Data*, page 19.

## 2.3 Safety information on electromagnetic interference

**WARNING!****Risk of malfunction due to electromagnetic interference**

Electromagnetic interference between this product and other electrical equipment can occur and disturb the electrical adjustment functions of this product. To prevent, reduce or eliminate such electromagnetic interference:

- Only use original cables, accessories and spare parts, to not increase electromagnetic emission or reduce electromagnetic immunity of this product.
- Do not use portable radio frequency (RF) communications equipment closer than 30 cm to any part of this product (including cables).
- Do not use this product near active high-frequency surgical equipment and the RF shielded room of a system for magnetic resonance imaging, where the intensity of electromagnetic disturbances is high.
- If disturbances occur, increase the distance between this product and the other equipment or switch it off.
- Refer to the detailed information and follow the guidance in chapter 9 *Electromagnetic compatibility (EMC)*, page 22.



**WARNING!**

**Risk of malfunction due to electromagnetic interference**

Do not use this bed adjacent to or stacked with other electrical equipment, than specified in the following, as it could result in improper operation. If such use is necessary, the bed and the other equipment must be closely observed to verify that they are operating normally.

This bed can be used together with Invacare approved accessories and medical electrical equipment connected to the heart (intracardially) or blood vessels (intravascularly) provided that following points are respected:

- Medical electrical equipment should not be fixed on the bed’s metallic accessories such as side rails, lifting pole, drip rod, bed ends, etc.
- The medical electrical equipment power supply cord should be kept clear of the accessories or any other moving parts of the bed.

	Type B applied part
	Do not dispose of this product in normal household waste
	European Conformity
	UK Conformity Assessed

Abbreviations for technical data:

- lin = Incoming Current
- Uin = Incoming Voltage
- Int. = Intermittence
- AC = Alternating Current
- Max = maximum
- min = minutes

For more information about technical data, refer to 8 *Technical Data, page 19.*

## 2.4 Labels and symbols on the product



### 2.4.1 Identification Label

The identification label is placed on the frame of the bed and contains the main product information, including technical data.

	Serial number
	Reference number
	Unique device identifier
	Manufacturer
	Date of manufacture
	Medical device
	Max. user weight
	Max. safe working load
	CLASS II equipment

### 2.4.2 Other Labels

Read the user manual before using this product and follow all instructions for safety and use.	
	The background colour of this symbol is blue on product labels.
	Definition of min. weight, min. height and min. body mass index of an adult user. <i>See Intended Use.</i>
	Refer to user documentation for the correct mattress measures. <i>See 8 Technical Data, page 19.</i>
	Total weight of the product with the maximum safe working load applied
	Temperature limit
	Humidity limitation
	Atmospheric pressure limitation

	Transport and storage conditions
	Operation conditions

Indicates, that the bed can be used with automatic washing systems. (Only present on washable versions of this product)

Marks out the location of connection for means of potential equalization. (Not present on all versions of this product)

**Label on 3/4 length side rails**

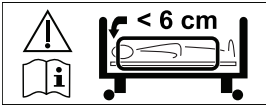
Indicates the maximum space between side rail and the head bed end.  See the mounting instruction in the service manual of the bed or the instruction delivered with the side rail.



## 3 Product Overview

### 3.1 Intended Use

The medical bed is electrically operated, adjustable in height and features a profiling support surface intended to be used in combination with a mattress. Medical beds are designed for support of the patient and used for the mitigation, relief, and recovery from certain medical conditions. The medical bed also supports and eases the caregivers' working environment.

The Medical bed is intended to be used on:

- *Application environment 3*; Long-term care in a medical area where medical supervision is required and monitoring is provided if necessary and medical electrical equipment used in medical procedures may be provided to help maintain or improve the condition of the patient.
- *Application environment 4*; Care provided in a domestic area where medical electrical equipment is used to alleviate or compensate for an injury, disability or disease.

#### Intended Users

A person with a medical condition that needs to be cared for in bed.

#### Indications

The bed is intended for adult users whose height is greater than or equal to 146 cm, weight is greater than or equal to 40 kg, and Body Mass Index (BMI) greater than or equal to 17.

The bed is intended for indoor use only.

Maximum user weight is 200 kg and safe working load is 235 kg.

#### Contra-indications

The bed is not intended for transportation of users. (It is mobile within a room with a user in it. Castors are lockable.)

The bed is not intended for persons with a psychosocial disability.



#### WARNING!

Any other or incorrect use could lead to hazardous situations.

Invacare accepts no liability for any use, change or assembly of the product, other than stated in this user manual.

#### 3.1.1 Intended Operator

A healthcare professional or private person who has received proper training is the intended operator of this product.

The hand control can also be operated by the occupant of the bed.

### 3.2 Main parts of bed

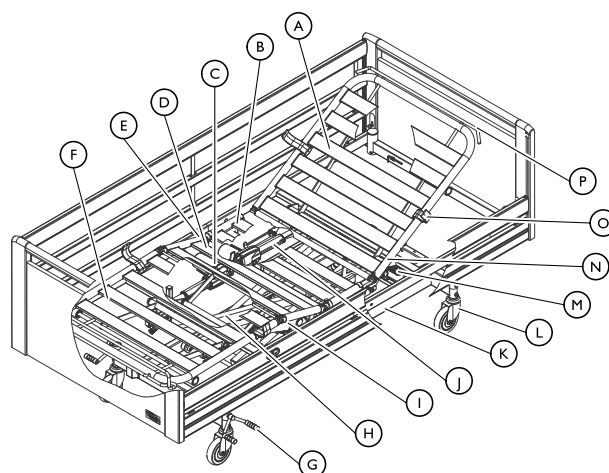

Parts of standard bed:

- |                         |                                |
|-------------------------|--------------------------------|
| Ⓐ Backrest              | Ⓛ Mattress support, lower half |
| Ⓑ Seat section          | Ⓜ Backrest motor               |
| Ⓒ Leg section motor     | Ⓨ Base Frame                   |
| Ⓓ Thigh section         | Ⓩ Brake - castor with brake    |
| Ⓔ Thigh section motor   | ⓐ Control Unit                 |
| Ⓕ Leg section           | ⓑ Mattress support, upper half |
| Ⓖ Brake pedal - central | ⓓ Mattress retainer            |
| Ⓗ Shear arms            | ⓔ Mattress support extension   |

### 3.3 Options



Due to regional differences, refer to your local Invacare website or catalog for details about available options or contact your Invacare provider.

#### Side rails

Side rails are intended to be operated by a person standing beside the bed and to reduce the risk for the user of unintentionally falling out of the bed, when locked in their uppermost position.

- **Britt V** – Collapsible full length wood side rail (standard, 10 cm extended or 20 cm extended)
- **Line** – Collapsible full length aluminum side rail (standard or extendable)
- **Scala** – Collapsible 3/4 length steel side rail (Basic 2, Basic Plus 2, Medium 2, Decubi 2)
- **Verso II** – Collapsible 3/4 length steel side rail
- **Height extenders** for full length side rails – 15 cm height increase (for Britt or for Line)
- **Covers** for side rails – textile covers for the different side rails (netted or padded)

For more details on side rails see *8 Technical Data, page 19*

#### Bed ends & side panels

Bed ends are intended to provide an esthetic and physical barrier at the head end and the food end of the bed. Bed ends with guideways are required to mount full length side rails.

- **Victoria, Sophie, Susanne** (standard and low) and **Anita** – bed ends with guideways for full length side rails

- **Emma, Piggy and Olivia** – bed ends without guideways for full length side rails
- **Wooden side panel** – esthetic cover for the side of the bed

For more details on bed ends see *8 Technical Data, page 19*

## Repositioning aids

Repositioning aids are intended to provide support to the user when getting in or out of the bed (support handles and stand-up support) or when changing position inside the bed (support handles, lifting pole and sit-up support).

- **Fixed support handles** – fixed handles to be mounted on the side of the bed (several height and length combinations)  
**NOT** to be used with Scala and Verso side rails.
- **Swiveling support handles** – swiveling handles to be mounted on the side of the bed (left or right)  
**NOT** to be used with side rails or side panels.
- **Sit-up support** – adjustable handle to be mounted on the side of the bed (left or right)  
**NOT** to be used with Scala and Verso side rails.
- **Stand-up support** – handle to be mounted on one of the lifting pole tubes at the head end of the bed

- **Lifting pole** – to be mounted on one of the lifting pole tubes at the head end of the bed (fixed or swivelling)

## Other

- **Distance bumpers** – buffers mounted on the beds base frame
- **Fender Wheels** – buffers mounted on bed ends
- **Transport Trolley** – to transporting and storing the assembled bed
- **IV Rack** – Holder for infusion bags to be mounted on one of the lifting pole tubes
- **Battery backup** – mounted on the base frame for short term operation without mains power supply
- **Soft Tilt** – Patient repositioning system mounted on the mattress platform
- **Rheumatic hand control** – Hand control for people with rheumatism
- **Holder for hand control** – to be mounted on the side of the bed
- **Y and Extension cable** – to use two hand controls at the same time and/or extend the cable of the hand control
- **LED lamp** – to be mounted on one of the lifting pole tubes

## 4 Usage

### 4.1 General Safety Information



**WARNING!**

**Risk of personal injury and damage to property.**

- The bed must be placed so that the height adjustment is not obstructed by, for example, lifts or furniture.
- Take care that no body parts are being squeezed between fixed parts (such as side rails, bed ends etc) and moving parts.
- The hand control must not be used by children.



**WARNING!**

**Risk of injury**

If the bed is used by confused or restless users or users with spasms:

- either, when the bed is equipped with a lockable hand control, lock the hand control functions,
- or make sure that the hand control is out of reach for the user.

#### 4.1.1 Mattress retainers



**WARNING!**

**Risk of injury**

Without properly installed mattress retainers, the mattress can slip sideways and cause the user to fall out of the bed.

- Never use the bed without mattress retainers.
- Always make sure the mattress retainers are properly installed and facing upwards.
- Only use the original mattress retainers.

### 4.2 Setup



**NOTICE!**

- Unpacking and setup of the bed must be performed by a qualified technician as described in the service manual.
- Accessories, delivered with the bed, must be assembled by a qualified technician as described in the service manual or in the documentation, delivered with the accessory.

#### Scope of delivery

- Complete bed with castors, control box and mattress support

Options, like bed ends, side rails, lifting pole etc. are delivered apart.

#### Before taking the bed into use

1. Move the bed to its correct position.
2. Connect the bed to the mains.

### 4.3 Operating side rails



**WARNING!**

**Risk of entrapment or suffocation**

There's a risk of entrapment or suffocation between mattress support, side rail and bed end.

- Always ensure correct fitting and tightening of the side rails.



**WARNING!**

**Risk of falling**

If it has been decided that the user needs side rails:

- Never leave the user unattended in the bed with the side rail down.
- Make sure the side rail is in its highest position and properly locked while leaving the user unattended.



**CAUTION!**

**Risk of Injury**

If the side rail is not locked properly it can fall down.

- Pull/push the top bar of the side rail to ensure that the locking system is properly engaged.



**CAUTION!**

**Risk of Injury**

There is a risk of entrapment or squeezing while operating the side rail.

- Pay attention to your fingers and body parts of the patient.
- Never force or drop the side rail while handling it.

#### 4.3.1 Operating Scala 2 side rail



**NOTICE!**

- When manoeuvring the side rail, place your hands only in the areas marked with the grip label.

1.

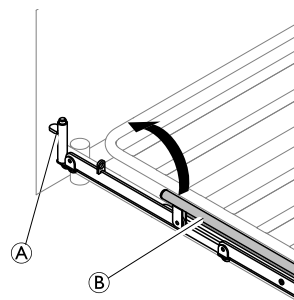

2.

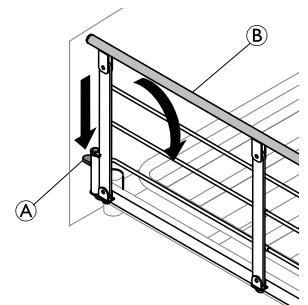

1. **Up:** Lift and pull the top bar **B** of the side rail towards the end with the locking mechanism (release button) **A**. Ensure, it is locked in place.
2. **Down:** Press the release button **A** and push the top bar **B** of the side rail away from the locking mechanism.

### 4.3.2 Britt V and Line side rails

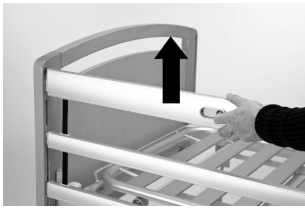

**Lock / Upper position**  
Pull up the top wooden side rail bar, until the locking pin locks with an audible click

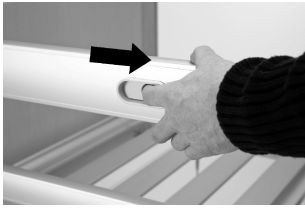

**Release**  
Lift the top wooden side rail bar and press the two locking rings together.



**Down / Lower position**  
Lower the side rail.

### Using a side rail height extender

Line and Britt V side rails can be supplemented by a height extender. A side rail height extender increases the allowed mattress thickness by 15 cm.



**WARNING!**  
**Risk of injury or death**

A misapplied side rail height extender could fall off. There's an increased risk for the user to fall out of the bed.

- Make sure that the side rail height extender is properly attached to the side rail. Refer to the user manual of the side rail height extender.
- Make sure to use the correct height extender for your side rail (the shape must match to the shape of the side rail. A label on the height extender determines to which side rail it belongs. See image below.

Height extender for LINE side rail:

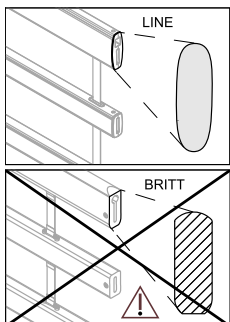

Height extender for BRITT V side rail:

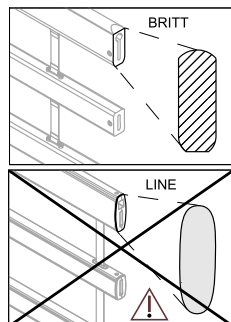

### 4.3.3 Verso II side rails

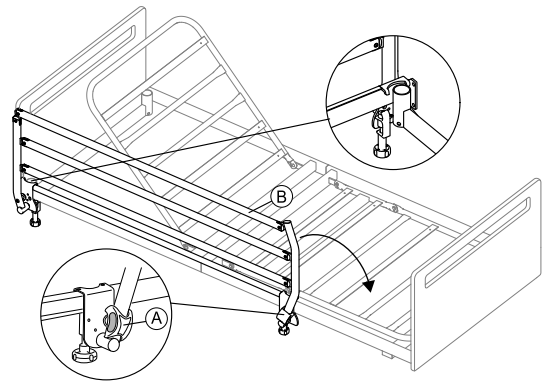

#### Folding down to open the side rail

1. Hold the top bar ⑥ with one hand and pull the locking button ① with the other hand.
2. Pull the top bar sideways and release the locking button.
3. Fold the side rail down to its lowest position.

#### Folding up to close the side rail

1. Pull the top bar ⑥ and raise the side rail until it is properly engaged in the locking system.

## 4.4 Hand Control

The **Hand Control** is equipped with **five** buttons to operate the electrical functions of the bed.

There is a version of the **Hand Control** which is equipped with a locking function.

#### Sitting position



1. Up: press left side of the button (▲).
2. Down: press right side of the button (▼).

#### Backrest section



1. Up: press left side of the button (▲).
2. Down: press right side of the button (▼).

#### Leg section



1. Up: press left side of the button (▲).
2. Down: press right side of the button (▼).

#### Thigh section



1. Up: press left side of the button (▲).
2. Down: press right side of the button (▼).

#### Height adjustment



1. Up: press left side of the button (▲).
2. Down: press right side of the button (▼).

### 4.4.1 Locking function



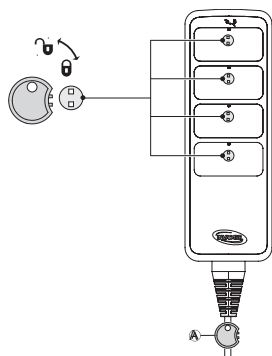



The locking function prevents usage of certain function buttons. Regardless of how many buttons your hand control has, they can all be locked individually.



1. Insert key **A** in the keyhole located just above the desired function.
2. To lock, turn the key clockwise.
3. To unlock, turn the key anti-clockwise.

## 4.5 Soft Control

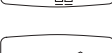
### Function buttons

	Press up to raise the bed.
	Press down to lower the bed.
	Sitting position
	Horizontal mattress support
	"Out of bed" button (Raises the backrest and brings the thigh section to horizontal)
	Thigh section
	Leg section

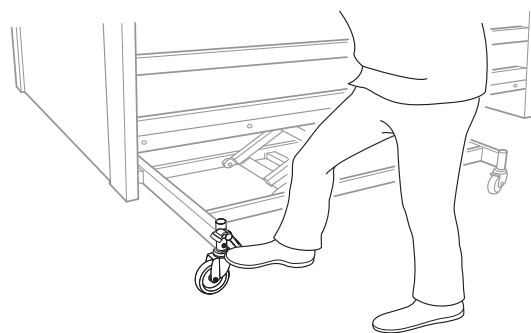

- i** Always stand in the middle of the bed's long side when locking the brakes.

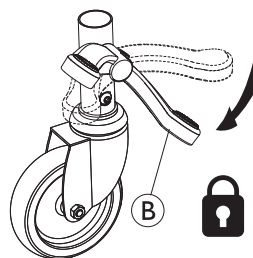

1. Lock the brakes:  
Step on the red pedal **B**.

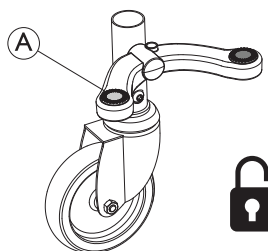

1. Unlock the brakes:  
Step on the green pedal **A** until the brake is in **neutral position** = Both pedals on the same level.

## 4.6 Castors and brakes

**CAUTION!**  
**Risk of trapping/squeezing**  
All brakes are foot-operated.  
– Do not release the brake with the fingers.

**CAUTION!**  
**Risk of injury**  
User can fall, while entering or exiting the bed, if brakes are not locked.  
– Always lock the brakes before the user is moving in or out of bed or when attending to the user.

**i** Castors might make marks on different types of absorbing floor surfaces - such as untreated or badly treated floors. To prevent marks, *Invacare*® recommends to place a suitable kind of protection between the castors and the floor.

### 4.6.1 Central brake system

All the wheels are locked by locking one of the pedals.

### Steerable castor (optional)

The bed with central braking system may be equipped with a steerable castor operated with the central braking pedal.

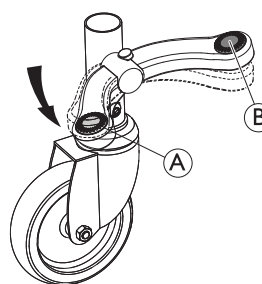

1. Activating the steering:  
When the brake is in neutral position, step on the green pedal **A**.
2. Deactivating the steering:  
When steering is activated; step on the red pedal **B**, until the brake is in neutral position.

## 4.7 Lifting pole

**WARNING!**  
**Risk of injury**  
The bed can tip if the handle is used, while the lifting pole is turned away from the bed.  
– The lifting pole always has to be positioned with the handle hanging over the bed area.  
– Do not exceed the maximum load of the lifting pole; 80 kg.

### 4.7.1 Place the lifting pole

The lifting pole can be placed either on the left or the right side of the head end of the bed.

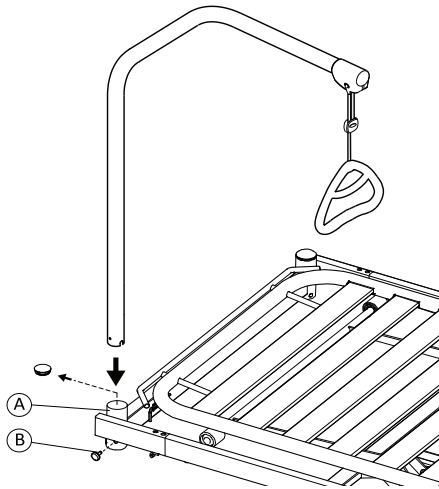

1. Remove the plastic plug from the lifting pole tube (A) at the head end of the bed.
2. Insert the lifting pole into the lifting pole tube and fix it with the finger screw (B).

 The swivel lifting pole must not be fixed with a finger screw, so that it can swing away to the side of the bed.

### 4.7.2 Adjusting the handle height

The handle height should always be adjusted to the user's need.

- 1.
- 2.

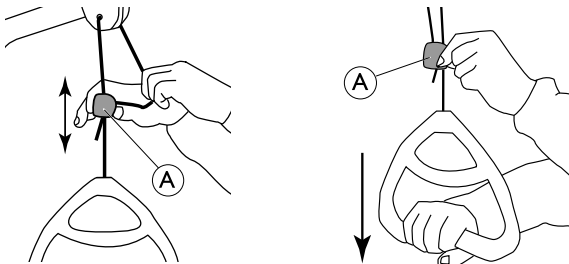

1. Hold the cord out while sliding the plastic cord lock (A) upwards or downwards until the handle reaches the preferred height.
2. Lock the handle by pressing back the cord in the lock (A) and pull the handle downwards.

**!** **NOTICE!**  
After adjusting the handle height:  
– Check that the two cords above the cord lock are parallel and inside the cord lock.  
– Make sure the cord is properly locked by pulling the handle hard.

## 4.8 Emergency positions

In case of a medical emergency, it might be required to bring all or certain mattress support sections into a flattened position - e.g. a flattened back section for cardiopulmonary resuscitation (CPR).

To bring a mattress support section into a flattened position,

- use the corresponding function on the hand control
- OR
- in case of power failure or urgent need for action, use the manual emergency release and lower the mattress support section.

Refer to 4.8.1 *Emergency release of a mattress support section*, page 14.

### 4.8.1 Emergency release of a mattress support section

In case of a power- or motor failure, an emergency release of the back, thigh or leg section could be necessary. An emergency release of the height adjustment is NOT possible.



**CAUTION!**  
**Risk of injury**

- A minimum of two persons is required for an emergency release of a mattress support section.
- When releasing a mattress support section, it might lower fast. Do not reach under the mattress support while lowering it.



**NOTICE!**

- Before an emergency release of the mattress support, remove the plug from the mains socket.

1. Both persons hold the mattress section.
2. One of them locates the motor in question and pulls out the safety pin.

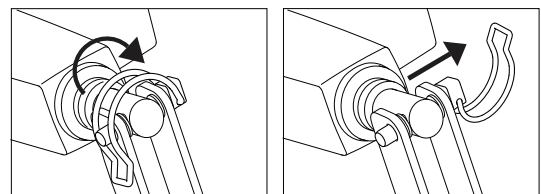

3. Both persons slowly lower the mattress section until it is completely down.

## 5 Maintenance

### 5.1 General maintenance information

**CAUTION!**
**Risk of injury or damage**

- Do not perform any maintenance or service procedures while the product is in use.

Follow the maintenance procedures described in this manual to keep your product in continuous operation.

Further maintenance and inspection procedures, to be performed by a qualified technician, are described in the service manual of this product. Service manuals can be obtained from Invacare.

#### 5.1.1 Service interval

We strongly recommend a full service to be performed at least every second year and a yearly check of the actuators.

Contact your Invacare provider or in-house service department for service.

### 5.2 Daily inspections

**WARNING!**
**Risk of injury or damage**

- Damaged or worn parts can affect the safety of the product.
- The product should be checked each time it is used.
  - Do not use the product if damage is found or you question the safety of any part of the product. Contact your Invacare provider immediately and ensure the product is not used until repairs are made.

#### Daily Inspection Checklist

- Visually inspect the bed. Check all parts for external damage or wear.
- Check all hardware, attachment points, stressed parts and any pivot points for signs of wear, cracking, fraying, deformation or deterioration.
- Check the hand control and all actuators for smooth operation.

### 5.3 Cleaning and Disinfection

#### 5.3.1 General safety information

**CAUTION!**
**Risk of contamination**

- Take precautions for yourself and use appropriate protective equipment.

**CAUTION!**
**Risk of electric shock and product damage**

- Switch off the device and disconnect from mains, if applicable.
- When cleaning electronic components consider their protection class regarding water ingress.
- Make sure that no water splashes to the plug or the wall outlet.
- Do not touch the power socket with wet hands.

**NOTICE!**

Wrong fluids or methods can harm or damage the product.

- All cleaning agents and disinfectants used must be effective, compatible with one another and must protect the materials they are used to clean.
- Never use corrosive fluids (alkalines, acid etc.) or abrasive cleaning agents. We recommend an ordinary household cleaning agent such as dishwashing liquid, if not specified otherwise in the cleaning instructions.
- Never use a solvent (cellulose thinner, acetone etc.) that changes the structure of the plastic or dissolves the attached labels.
- Always make sure that the product is completely dried before taking into use again.



For cleaning and disinfection in clinical or long-term care environments, follow your in-house procedures.

#### 5.3.2 Cleaning Intervals

**NOTICE!**

Regular cleaning and disinfection enhance smooth operation, increases the service life and prevents contamination.

Clean and disinfect the product:

- regularly while in use,
- before and after any service procedure,
- when it has been in contact with any body fluids,
- before using it for a new user.

#### 5.3.3 Cleaning Instructions

**NOTICE!**

Only certain components of the product tolerate cleaning in automatic washing systems or with high pressure cleaning equipment.

- For detailed information on cleaning in automatic washing systems or with high pressure cleaning equipment see the Service Manual of the product
- All other components must be cleaned by hand.

#### Cleaning by Hand

**All components** (excluding removable textiles)

- Cleaning agent: We recommend using a mild detergent with neutral or near neutral pH (5-9).



Commercially available consumer products like hand dishwashing liquid or all-purpose cleaners can be used. Read the instructions on the label of your cleaning agent and use it at the indicated concentration.

- Max. water temperature: 40 °C
1. Wipe surfaces thoroughly with a soft cloth slightly moistened with detergent solution until all visible soil is removed.
  2. Remove all detergent residue with a clean damp cloth.
  3. Wipe dry using a clean soft cloth.

#### **Removable textiles** (including upholstery and mattresses)

- See attached label on each product.

### **5.3.4 Disinfection Instructions**

#### **In Domestic Care**

- Disinfectant: We recommend using an alcohol-based surface disinfectant (with 70-90% alcohol).



Read the instructions on the label of your disinfectant. It provides information on the activity spectrum (bacteria, fungi and/or viruses), material compatibility and the correct exposure time.

1. Ensure the surfaces are cleaned before disinfection.
2. Moisten a soft cloth and wipe-disinfect all accessible surfaces and keep them moistened for the exposure time stated on the label of the disinfectant.
3. Allow the product to air-dry.

#### **In Institutional Care**

Follow your in-house disinfection procedures and only use the disinfectants and methods specified therein.

### **5.4 Lubrication**

Check the bed's lubrication points, and adequately grease them, at least every second year, following the service manual specifications.



---

## 6 After Use

---

### 6.1 Disposal

Be environmentally responsible and recycle this product through your recycling facility at its end of life.

Disassemble the product and its components, so the different materials can be separated and recycled individually.

The disposal and recycling of used products and packaging must comply with the laws and regulations for waste handling in each country. Contact your local waste management company for information.

### 6.2 Reconditioning

This product is suitable for reuse. To recondition the product for a new user, carry out the following actions:

- Inspection
- Cleaning and disinfection

For detailed information, see *5 Maintenance, page 15* and the service manual for this product.

Make sure that the user manual is handed over with the product.

If any damage or malfunction is detected, do not reuse the product.

## 7 Troubleshooting

### 7.1 Troubleshooting

Symptom	Possible cause	Remedy
Bed section does not move	End of stroke reached	Operate opposite button
Full bed: No electric function does work	Bed not plugged in	Plug in mains cable
	Hand control not connected	Ensure hand control correctly connected to control unit.
	Hand control defective	Call dealer / technician to replace hand control
	Control unit defective	Call dealer / technician to replace control unit
	Cables entangled or pinched	Call dealer / technician to replace cables
Side rail does not open or close	Locking mechanism defective	Call dealer / technician to repair side rail

## 8 Technical Data

### 8.1 Dimensions bed

- All measurements are stated in cm.
- All angles are stated in degrees.
- All measurements and angles are stated without tolerances.

Length measures are stated for a non-extended bed. The bed can be extended respectively 5 and 10 cm's in both ends.

Height measures are stated for a bed with castors of 10 cm diameter. With smaller or bigger castors, the heights differ accordingly.

Invacare® reserves the right to change the stated measurements and angles without warning.

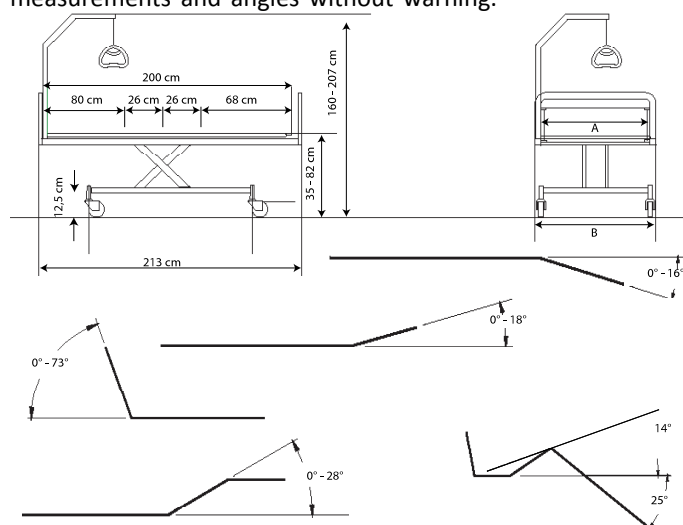



SB 755	
Mattress support width A	85 / 90 / 105 / 120 cm
Total width B	95 / 100 / 115 / 130 cm
Mattress support length	200 (80+26+26+68) cm
Total length	213 cm
Bed to floor height	35 – 82 cm
Base to floor height	15 cm
Total height (with lifting pole)	160 – 207 cm

### 8.2 Dimensions side rails

Side rail	Type	Measures	Information
Line standard	Full length aluminium side rail	206 cm x 40 cm	Mounted on the bed end guideways. Release buttons in the middle.

Line Extendable	Full length aluminium side rail with telescopic extension	206-226 cm x 40 cm	Mounted on the bed end guideways. Release buttons in the middle.
Britt V	Full length wood side rail	205 cm x 40 cm	Mounted on the bed end guideways. Release buttons in the middle.
Scala Basic 2 / Scala Basic Plus 2	3/4 length collapsible steel side rail	168 cm x 40 cm	Mounted on the side tube. Release button in the head section.
Scala Medium 2	3/4 length collapsible steel side rail	165 cm x 46 cm	Mounted on the side tube. Release button in the head section.
Scala Decubi 2	3/4 length collapsible steel side rail	168 cm x 54 cm	Mounted on the side tube. Release button in the head section.
Verso II	3/4 length collapsible steel side rail	156 cm x 40 cm	Mounted on the side tube. Release button in the foot section.

### 8.3 Maximum weights

	Max. user weight (provided that the weight of the mattress and the accessories do not exceed 35 kg)	200 kg
	Max. safe working load (including accessories)	235 kg

### 8.4 Weights

	Mattress support [width 85 / 90 cm]	Mattress support [width 105 cm]	Mattress support [width 120 cm]
Complete bed (excluding accessories)	88 kg	107 kg	117 kg

Mattress support (upper half)	25 kg	34 kg	37 kg
Mattress support (lower half)	23 kg	33 kg	36 kg
Shear arms (standard)	40 kg	40 kg	44 kg
Shear arms (dismountable)	18 kg	—	—

### Weights | Bed parts and Options

	Mattress support [width 85 / 90 cm]	Mattress support [width 105 cm]	Mattress support [width 120 cm]
Side rail Line	4,5 kg/pc	4,5 kg/pc	4,5 kg/pc
Side rail Line (extendable)	6,5 kg/pc	6,5 kg/pc	6,5 kg/pc
Side rail Britt V	7,7 kg/pc	7,7 kg/pc	7,7 kg/pc
Side rail Britt V (extended +10)	9,1 kg	9,1 kg	9,1 kg
Side rail Britt V (extended +20)	9,5 kg	9,5 kg	9,5 kg
Side rail Scala 2	7,4 kg/pc	7,4 kg/pc	7,4 kg/pc
Side rail Verso II	9,3 kg	9,3 kg	9,3 kg
Bed end Emma	7 kg/pc	—	—
Bed end Victoria	10 kg/pc	—	—
Bed end Susanne	8,5 kg/pc	9,5 kg/pc	10,5 kg/pc
Bed end Sophie	8,5 kg/pc	9,5 kg/pc	10,5 kg/pc
Bed end Anita	9 kg/pc	—	—
Bed end Piggy	6 kg/pc	—	—
Bed end Olivia	9,5 / 10 kg (head end) 6,5 kg (foot end)	—	—
Lifting pole	4,2 kg	4,2 kg	4,2 kg

### Weights | Wooden Side Panel

	Panel [length 200 cm]	Panel [length 210 cm]	Panel [length 220 cm]
For standard bed end	5,7 kg	5,9 kg	6,2 kg
For lowered bed end	6,6 kg	6,8 kg	7,1 kg
For use with side rail Scala	7,1 kg	7,4 kg	7,7 kg

## 8.5 Allowed mattress sizes

### Allowed mattress Heights and Lengths

 Allowed **Heights** and **Lengths** depend on the side rail model used

Bed side rails	Allowed mattress sizes		
	Max height (cm)	Min height (cm)	Min length (cm)
Line/ Line Extendable	18	12	200
Britt V	18	12	200
Scala Basic 2	15	8	200
Scala Basic Plus 2	15	8	200
Scala Medium 2	20	8	200
Scala Decubi 2	29	21	200
Verso II	18	10	200

### Allowed mattress Widths

 Allowed **Widths** are applicable for all side rail models

Bed width	Allowed mattress width
85 cm	83–85 cm
90 cm	88–90 cm
105 cm	103–105 cm
120 cm	118–120 cm

## 8.6 Materials

<b>Mattress Platform</b>	Steel (powder-coated) and/or Aluminium
<b>Base Frame and Shear arms</b>	Steel (powder-coated)
<b>Bed Ends</b>	Wood and/or MDF (Zinc-plated fixation brackets)
<b>Side Rails</b>	Steel (powder-coated), Wood or Aluminium
<b>Lifting Pole</b>	Steel (powder-coated), PP and POM
<b>Actuators housing, Hand control, Control box, Castors and other Plastic parts</b>	Material according to marking (PA, PP, PE, ABS)
<b>Bolts and nuts</b>	Steel (Zinc-plated)

## 8.7 Environmental conditions

	Storage and Transportation	Operation
Temperature	-10°C to +50°C	+5°C to +40°C
Relative humidity	20% to 80% - not condensing	
Atmospheric pressure	700 hPa to 1060 hPa	

-  Allow the product to reach operation temperature before usage:
- Warming up from minimum storage temperature might take up to 24 hours.
  - Cooling down from maximum storage temperature might take up to 24 hours.

### 8.8 Electrical system

<b>Voltage supply</b>	Uin 100–240 Voltage, AC, 50 / 60 Hz (AC = Alternating current)
<b>Maximum current input</b>	lin max. 2.5 Ampere
<b>Intermittent (periodic motor operation)</b>	10 % 2 min ON / 18 min OFF
<b>Insulation class</b>	CLASS II equipment
<b>Type B Applied Part</b>	Applied Part complying with the specified requirements for protection against electrical shock according to IEC60601-1.

<b>Sound level</b>	55 dB (A)
<b>Degree of protection</b>	<p>The control unit, motors and hand control are protected according to IPx6 or IPx6w (depend on configuration). See bed product label and label on each electric device for correct IP class. The lowest IP-classification defines the overall classification of the bed.</p> <p><b>IPx6</b> - The system is protected against water projected from any direction (not high pressure).</p> <p><b>IPx6w</b> - The system is protected against high pressurized water and steam projected from any direction.</p>

 The bed has no isolator (main switch). If the bed needs to be electrically disconnected, it has to be unplugged from the mains socket.

## 9 Electromagnetic compatibility (EMC)

### 9.1 General EMC information

Medical Electrical Equipment needs to be installed and used according to the EMC information in this manual.

This product has been tested and found to comply with EMC limits specified by IEC/EN 60601-1-2 for Class B equipment.

Portable and mobile RF communications equipment can affect the operation of this product.

Other devices may experience interference from even the low levels of electromagnetic emissions permitted by the above standard. To determine if the emission from this product is causing the interference, run and stop running this product. If the interference with the other device operation stops, then this product is causing the interference. In such rare cases, interference may be reduced or corrected by the following:

- Reposition, relocate, or increase the separation between the devices.

### 9.2 Electromagnetic emission

#### Guidance and manufacturer's declaration

This product is intended for use in the electromagnetic environment specified below. The customer or the user of this product should assure that it is used in such an environment.

Emissions test	Compliance	Electromagnetic environment - guidance
RF emissions CISPR 11	Group I	This product uses RF energy only for its internal function. Therefore, its RF emissions are very low and are not likely to cause any interference in nearby electronic equipment.
RF emissions CISPR 11	Class B	This product is suitable for use in all establishments including domestic establishments and those directly connected to the public low-voltage power supply network that supplies buildings used for domestic purposes.
Harmonic emissions IEC 61000-3-2	Class A	
Voltage fluctuations /flicker emissions IEC 61000-3-3	Complies	

### 9.3 Electromagnetic Immunity

#### Guidance and manufacturer's declaration

This product is intended for use in the electromagnetic environment specified below. The customer or the user of this product should assure that it is used in such an environment.

Immunity test	Test / Compliance level	Electromagnetic environment – guidance
Electrostatic discharge (ESD) IEC 61000-4-2	± 8 kV contact ± 2 kV, ± 4 kV, ± 8 kV, ± 15 kV air	Floors should be wood, concrete or ceramic tile. If floors are covered with synthetic material, the relative humidity should be at least 30 %.
Electrostatic transient / burst IEC 61000-4-4	± 2 kV for power supply lines; 100 kHz repetition frequency ± 1 kV for input / output lines; 100 kHz repetition frequency	Mains power quality should be that of a typical commercial or hospital environment.
Surge IEC 61000-4-5	± 1 kV line to line ± 2 kV line to earth	Mains power quality should be that of a typical commercial or hospital environment.

Immunity test	Test / Compliance level	Electromagnetic environment – guidance
Voltage dips, short interruptions and voltage variations on power supply input lines IEC 61000-4-11	< 0% $U_T$ for 0,5 cycle at 45° steps 0% $U_T$ for 1 cycles 70% $U_T$ for 25 / 30 cycles < 5% $U_T$ for 250 / 300 cycles	Mains power quality should be that of a typical commercial or hospital environment. If the user of this product requires continued operation during power mains interruptions, it is recommended that the product is powered from an un-interruptible power supply or a battery.  $U_T$ is the a. c. mains voltage prior to application of the test level.
Power frequency (50/60 Hz) magnetic field IEC 61000-4-8	30 A/m	Power frequency magnetic fields should be at levels characteristic of a typical location in a typical commercial or hospital environment.
Conducted RF IEC 61000-4-6	3 V 150 kHz to 80 Mhz  6 V in ISM & amateur radio bands	Field strengths from fixed transmitters, such as base stations for radio (cellular/cordless) telephones and land mobile radios, amateur radio, AM and FM radio broadcast and TV broadcast cannot be predicted theoretically with accuracy. To assess the electromagnetic environment due to fixed RF transmitters, an electromagnetic site survey should be considered. If the measured field strength in the location in which this product is used exceeds the applicable RF compliance level above, this product should be observed to verify normal operation. If abnormal performance is observed, additional measures may be necessary, such as reorienting or relocating this product.  Interference may occur in the vicinity of equipment marked with the following symbol: 
Radiated RF IEC 61000-4-3	10 V/m 80 Mhz to 2,7 GHz  385 MHz - 5785 MHz test specifications for immunity to RF wireless communication equipment refer to table 9 of IEC 60601-1-2	Portable and mobile RF communications equipment should be used no closer than 30 cm to any part of this product including cables.

 These guidelines may not apply in all situations. Electromagnetic propagation is affected by absorption and reflection from structures, objects and people.

## 9.4 Test specifications for immunity to RF wireless communications equipment

IEC 60601-1-2— Table 9

Test Frequency (MHz)	Band <sup>a)</sup> (MHz)	Service <sup>a)</sup>	Modulation <sup>b)</sup>	Immunity test level (V/m)
385	380 - 390	TETRA 400	Pulse modulation <sup>b)</sup> 18 Hz	27
450	430 - 470	GMRS 460, FRS 460	FM <sup>c)</sup> ± 5 kHz deviation 1 kHz sine	28
710 745 788	704 - 787	LTE Band 13, 17	Pulse modulation <sup>b)</sup> 217 Hz	9
810 870 930	800 - 960	GSM 800/900, TETRA 800, iDEN 820, CDMA 850, LTE Band 5	Pulse modulation <sup>b)</sup> 18 Hz	28

Test Frequency (MHz)	Band <sup>a)</sup> (MHz)	Service <sup>a)</sup>	Modulation <sup>b)</sup>	Immunity test level (V/m)
1720 1845 1970	1700 - 1990	GSM 1800; CDMA 1900; GSM 1900; DECT; LTE Band 1, 3, 4, 25; UMTS	Pulse modulation <sup>b)</sup> 217 Hz	28
2450	2400 - 2570	Bluetooth, WLAN, 802.11 b/g/n, RFID 2450, LTE Band 7	Pulse modulation <sup>b)</sup> 217 Hz	28
5240 5500 5785	5100 - 5800	WLAN 802.11 a/n	Pulse modulation <sup>b)</sup> 217 Hz	9

 If necessary to achieve the immunity test level, the distance between the transmitting antenna and the Medical Electrical Equipment or System may be reduced to 1 m. The 1 m test distance is permitted by IEC 61000-4-3.

<sup>a)</sup> For some services, only the uplink frequencies are included.

<sup>b)</sup> The carrier shall be modulated using a 50 % duty cycle square wave signal.

<sup>c)</sup> As an alternative to FM modulation, 50 % pulse modulation at 18 Hz may be used because while it does not represent actual modulation, it would be worst case.











**United Kingdom & Ireland:**

Invacare Limited  
Pencoed Technology Park, Pencoed  
Bridgend CF35 5AQ  
Tel: (44) (0) 1656 776 200  
uk@invacare.com  
www.invacare.co.uk



Invacare UK Operations Limited  
Unit 4, Pencoed Technology Park,  
Pencoed  
Bridgend CF35 5AQ  
UK



Invacare Portugal, Lda  
Rua Estrada Velha 949  
4465-784 Leça do Balio  
Portugal



1567446-M  
2024-08-14



**Making Life's Experiences Possible®**



**Yes, you can.®**